

Step 4: Connect the cables and power supply.

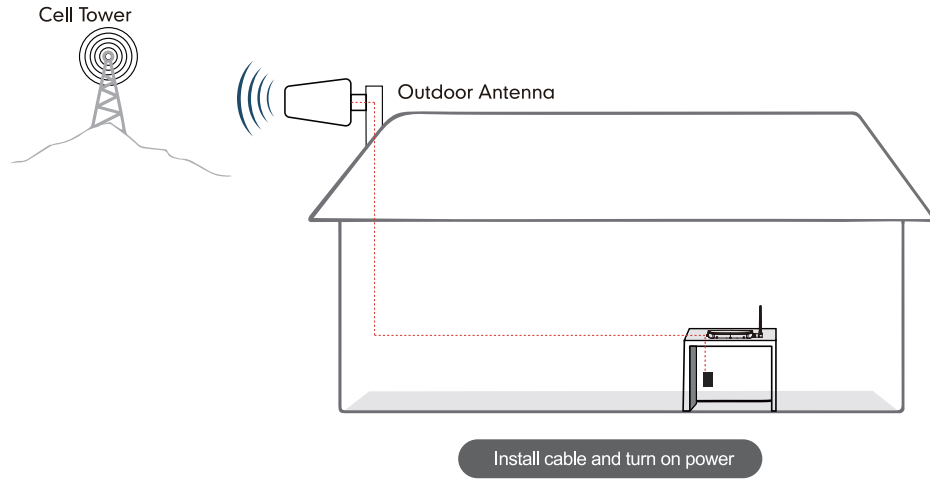

Step 5: Enjoy your signal!

This is a CONSUMER device.

**BEFORE USE**, you **MUST REGISTER THIS DEVICE** with your wireless provider and have your provider's consent. Most wireless providers consent to the use of signal boosters. Some providers may not consent to the use of this device on their network. If you are unsure, contact your provider.

In Canada, **BEFORE USE**, you must meet all requirements set out in ISED CPC-2-1-05.

You **MUST** operate this device with approved antennas and cables as specified by the manufacturer. Antennas **MUST** be installed least 20 cm (8 inches) from (i. e., **MUST NOT** be installed within 20 cm of) any person.

You **MUST** cease operating this device immediately if requested by the FCC (or ISED in Canada) or a licensed wireless service provider.

**WARNING.** E911 location information may not be provided or may be inaccurate for calls served by using this device.

This device may be operated **ONLY** in a fixed location (i.e., may operate in a fixed location only) for in-building use.



## Quick Installation Guide

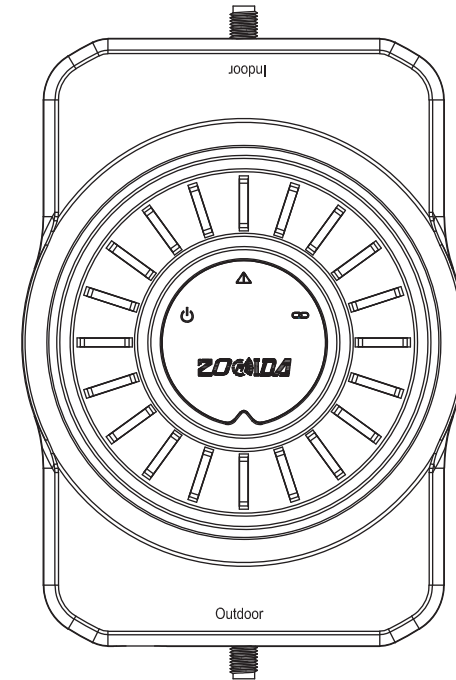

Ace 5S



Scan the QR code to access our app and get more information about the Ace 5S, including product details and user manual.



# Find the cell tower

- (1) Enter cellmapper.net
- (2) Choose your own carrier and band here.

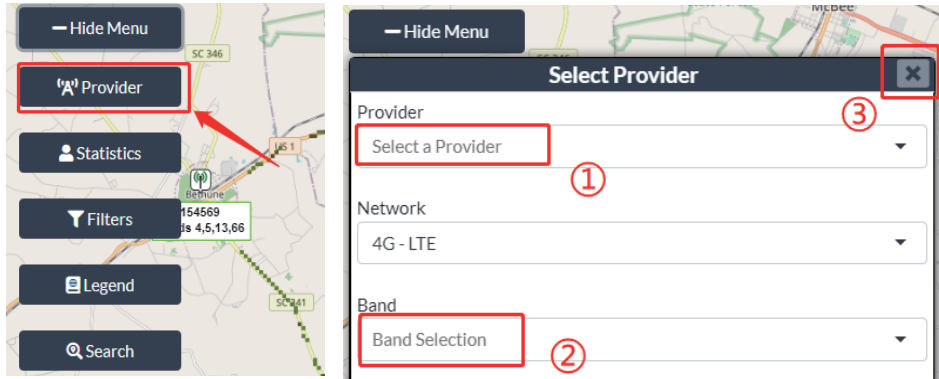

- (3) Then enter the coordinate of where you are trying to install the signal booster, and press Enter key. (In fact when you open Cellmapper, the map on the right will automatically locate your area if you've given the site permission to access your location. If you found tower sites not even displayed on the map, it might be because the app intercepts the locations for security reasons.)

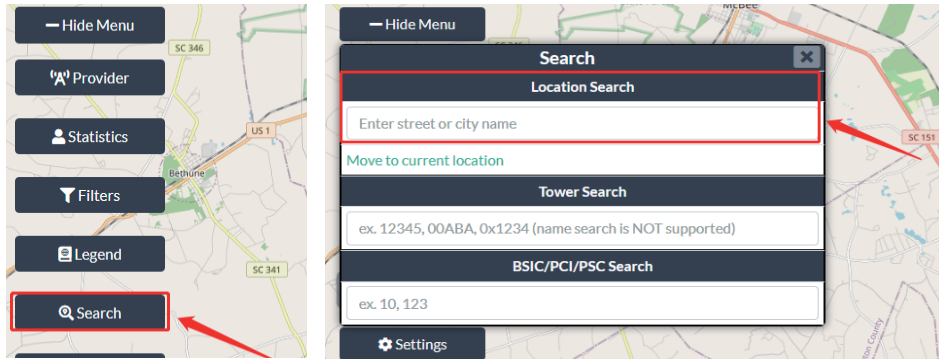

- (4) After the map jumps to the location, you can scroll the mouse pulley and zoom it out, then you will see the tower near the location. It would be better to take a screenshot of this page to guide the following installation steps. Should you have any questions, please contact our tech support.

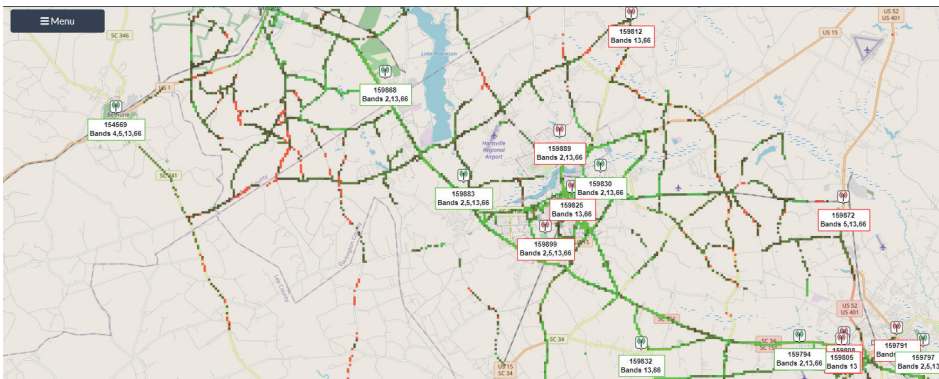

# Installation steps

- Step 1: Utilize the website cellmapper.net to locate the nearest cell tower to your mobile signal.
- Step 2: Install the outdoor antenna and align it with the located cell tower.

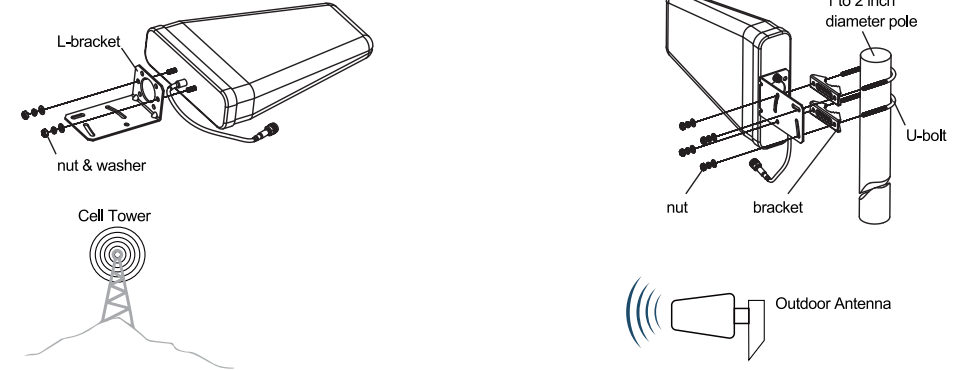

Install outdoor antenna

- Step 3: Install the indoor antenna and keep it approximately 10 meters away from the outdoor antenna in a straight line.

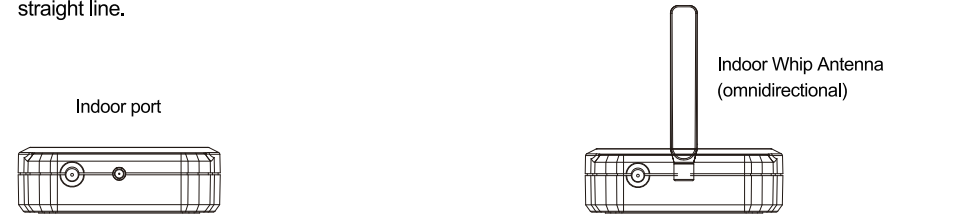

Install indoor antenna

